

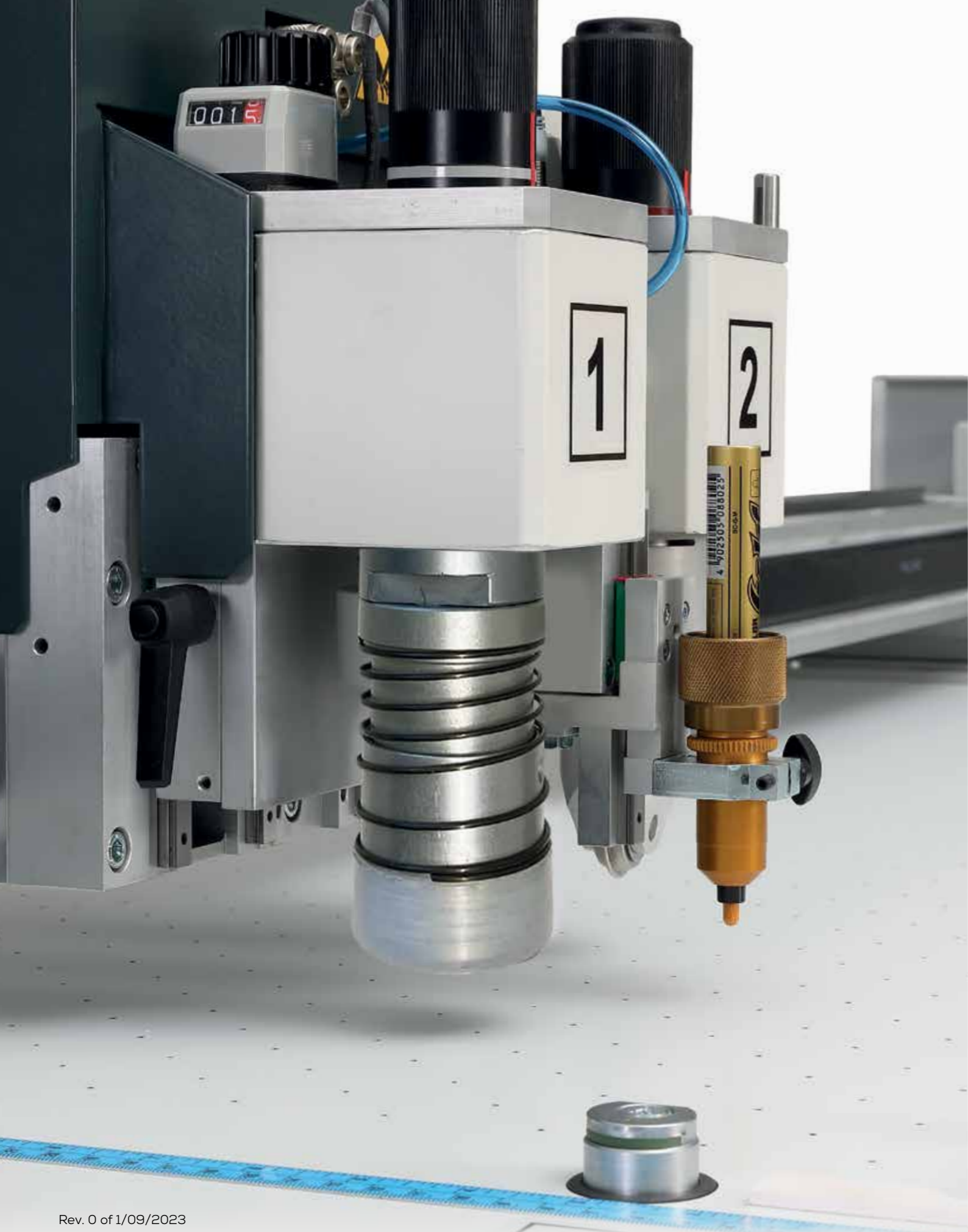

valiani

your perfect cut



Valiani cutting machines, excellence since 1974

Valiani is the perfect expression of the **Italian Engineering**. From the invention of the first mat cutting machine for the framing industry to recent machinery for printing, packaging and sign industry, our goal is providing you an everyday partner, capable to process the widest range of materials.

The numbers of our success



We export to more than

+90
countries



Carried out over

+5.000
installations

We have been exporting our cutting machines to more than 90 countries, where we have carried out over 5,000 installations, ensuring first-class service. Our mat-board cutting machines for framing is chosen by museums such as the **Vatican Museums**, the **Louvre**, **Musée d'Orsay**, the **Hermitage**, the **SF MOMA**, **Tokyo National Museum**, **Getty Museum**, **Finnish Museum of Contemporary Art Kiasma**, and other prestigious institutions such as, **European Parliament**, **NY Public Library**, **The White House** and many more.

Cutting machines beyond expectations

Know-how, Integrity, Passion and Sense of Accountability are the values guiding our long-standing company. These features have led us to be a reference point in the finishing industry. We are committed to meeting and exceeding our customers' expectations, anticipating their needs and ensuring high-quality service.



Summa Group

After nearly five decades of building equipment for Framing Industry and most recently Packaging and Sign industry, Valiani has become part of a new industrial group. Since July 2022 Summa NV, world leader in the production of roll-to-roll and flatbed cutters, has acquired Valiani to strengthen its position

as a leading manufacture in finishing equipment.

The merged business will continue as before and will complement each other to offer customers an even broader range of cutting solutions.

Rev. 0 of 1/09/2023

The information contained in the catalogs or any advertising printed materials, such as the technical characteristics of the products or the components, dimensions, assembly diagrams, colours, etc., are merely indicative, due to the technical specifications and the technological evolution of the company products. Important data may be provided from time to time and upon explicit request. In order to improve the quality of the product, Valiani S.r.l. reserves the right to modify the same without any notice and even after acceptance of the order. The company reserves the right to make partial or total changes to the products without any notice, declining all responsibility for any inaccurate data.

Passion for Made in Italy since 1974

Lean manufacturing: zero defects for absolute reliability

Lean methodology is a way of optimising the people, resources, efforts and energies of our organization toward creating value for the customers. It is based on two guiding tenets, continuous improvement and respect for people.

Thanks to the consistent application of this methodology, we can produce machinery with no waste and no defects, allowing us to deliver equipments that last over time.

The quality of our cutting machines is a warranty!

Every day we work to give the best to our customers.

Our cutting machines are the result of Italian genius and craftsmanship. We use Italian mechanics and thanks to zero defects lean management methodology we have increased the reliability of our flatbed plotters, so that we are able to offer a **5-year warranty on most of our machines.**

ONLY WITH US

5
YEAR*

WARRANTY

We are the only ones to offer these conditions!

Get peace of mind with a 5-year Valiani Limited
Manufacturers' Warranty

* Ask your local dealer for warranty details.

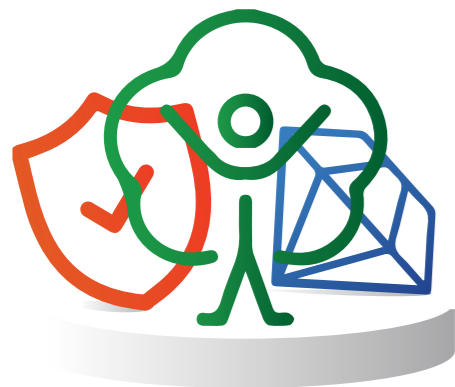

COMPANY POLICY

Integrated management system

Valiani S.r.l. has been developing an Integrated Management System compliant with the requirements of **UNI EN ISO 45001: 2018** - Health and Safety, **UNI EN ISO 14001: 2015** - Environment and **UNI EN ISO 9001: 2015** - Quality, promoting ever greater integration within the context of business management systems. With a view to expanding its presence in its reference markets, Valiani aims at characterizing itself as an advanced organization in terms of flexibility, innovation and professionalism. Needless to say, that the production and the export of its machinery as well as the provision of its services requires a full respect of the legal requirements, the safeguard of the environment and the protection of health and safety at work, thereby improving the quality of the products and their efficiency. All these criteria are fully met by Valiani company, which is preparing to become a symbol of expertise, competence and good practice at the working level.

Our values



QUALITY

Conceiving and developing cutting systems designed to last over time.



RELIABILITY

Living up to expectations and keeping promises, offering our customers equipment with great potential and establishing transparent relationships with end-user, partners, dealers and distributors.



INNOVATION AND TECHNOLOGY

Creating brand-new solutions, thinking in an unconventional way to allow our customers to develop and increase their business with highly technological machines.



SUSTAINABILITY

Managing natural resources and energy connected to production processes in a rational and sustainable way, so as to enhance their usage by reducing waste and polluting effects, in line with the condition of sustainable development whose main objective is ensuring the satisfaction of needs of the present generation without compromising the possibility of future generations to realize theirs.



SAFETY

Allowing people to operate in a safe and comfortable working environment.



HEALTH AND SAFETY

Priority to people:
we strive every day
to guarantee the well-being
and safety of all employees
in order to inspire confidence

VIEW THE QR-CODE



ENVIRONMENT

Environmental Protection:
we strive with passion to reduce
the environmental impact
by pursuing initiatives
of recycling or CO2 reduction

VIEW THE QR-CODE



QUALITY

Attention for our customers:
we care about maintaining
stringent standards
for all our activities
and provide customers
with an excellent service

VIEW THE QR-CODE



Valiani for a sustainable world

Together with quality and working safety, environmental sustainability is one of the three cornerstones of our company policy. Having a positive impact on the planet is a commitment that we pursue with concrete actions, which we implement both within the company and externally. At Valiani we rationally manage natural resources and energy connected to production processes, with the aim of reducing waste and polluting effects.

Valiani and Treedom A global commitment in defense of the planet

Valiani is an active partner of Treedom in the development of projects with a strong environmental and social impact. With this partnership we are committed to reducing carbon emissions into the atmosphere and ensuring sustainable development of the local communities involved in our projects.

Why we chose Treedom

We have chosen to collaborate with Treedom because it is a reliable company, which is part of the Certified B Corporations. Treedom helps rural communities around the world to realize sustainable ecosystems and allows thousands of farmers to support the initial costs of planting new trees, ensuring food sovereignty and income opportunities over time.



Food safety



**CO2
Compensation**



**Economic
Development**



**Environmental
Protection**

Find out more





We are in business to help our customers succeed

Vision

AFFORDABLE AND RELIABLE EQUIPMENT

With 50 years of experience, we work every single day to deliver high-yield machinery, bring innovation in the digital cutting solutions and offer our customers the best market compromise between price, performance and productivity.

Mission

INNOVATION AND TECHNOLOGY FOR EVERYONE

We strongly believe that the future of manufacturing lies in the digitalization process and our goal is to enable our customers to develop their business with our engineered cutting systems.

Values

OUR DAY-TO-DAY COMMITMENT

Know-how, Integrity, Passion and Accountability are what sets us apart, allowing us to exceed our customers' expectations.

SUPERIOR MANUFACTURING, QUALITY AND RELIABILITY

All Valiani machines are designed and developed with the aim to make them last forever. Repeatability and reliability are two factors that summarize the concept of quality asseverated in Valiani.

Materials and Applications

Digital machines to process your jobs

One of the key features of our digital machines is their versatility. They can be used for cutting a wide range of materials, with different thicknesses, always guaranteeing maximum precision and impeccable quality both on prototypes and from small medium cutting runs.

COUNTLESS MATERIALS, ENDLESS APPLICATIONS



Folding Carton / Corrugated Cardboard



Honeycomb panels



Grey chipboard



PVC / FOREX / Foam



Polycarbonate panels



Polymers and rubber blankets / Offset varnishing plates



Reflective films / Stickers and Decals / Vinyl



Magnets



Carbon Fiber



Moquette / Floor mats



Leather and Fabrics



Paper patterns



Medium-density fiberboard



Plexiglass and Acrylic



Aluminum composite / Dibond















Industries

Suitable for different industries and businesses

Our cutting machines feature amazing flexibility and works equally well for many different industries. They can be used for package prototyping for short and medium run, digital and offset printing, architectural models and picture framing. The right solution for every cutting need.

CHOOSE THE IDEAL CUTTING MACHINE FOR YOUR INDUSTRY

- Graphic Design Studios 
- Box Makers 
- Graphic Industries 
- Die Cutting Maker 
- Copy Shops 
- Offset Printing Press 
- Architects 
- Fashion and Apparel 
- Museums and Galleries 
- Framers and Photographs 

Index

Invicta Series

80/120/150

p. 18

Optima Series

80/160/250

p. 22

XL 300

p. 26

Integra Series

160/250/200/300

p. 28

Omnia Series

80/100

p. 32

Tools and Holders

p. 38

Holdings

p. 40

Tools

p. 42

Interchangeable Heads

p. 46

Software and Programs

p. 51

V-Studio

p. 52

M3 and M3 Art

p. 54

Opticrop

p. 60

Customer Experience Center

p. 62

INVICTA SERIES 80/120/150

COMPACT CUTTING MACHINE WITH INVINCIBLE VERSATILITY

Invicta is the ultimate digital cutting machine of the Valiani products. With its unique features and its **extreme versatility** gives you the ability to make virtually unlimited projects. Invicta guarantees a very high degree of precision matched with cutting and creasing quality almost equal to that of traditional die-cutting process. Invicta is also highly demanded in the fashion industry, allowing to cut and draw on textile and paper patterns.



ALL YOU NEED TO START A BUSINESS

Invicta with multiple optional cutting tools, as well as creasing and drawing tools, is ideally suited for cutting a wide range of materials. Our proven mechanical design and easy to use software ensure a quick solution to time-consuming tasks.

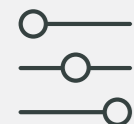

COMPACT, VERSATILE AND EASY-TO-USE

Invicta comes in different sizes, all with vacuum table and pneumatic clamping system; a **camera for crop mark detection** is also considered in the machine bundle. The sturdy design of the machine allows to cut precisely and efficiently any material. A bunch of tools are available with a view to its personalization. OptiCrop software is listed as an accessory.



CHANGE THE TOOLS IN 8 SECONDS

The possibility to easily swap one tool with another one enables the user to create the perfect configuration for various cutting requirements.



For more information scan the QR code or visit our website at www.valiani.com

**SINGLE
INTERCHANGEABLE
HEAD**



Materials

- Folding Carton
- Corrugated Cardboard
- Vinyl and magnets
- Reflective films
- PVC / FOREX / Foam
- Polymers and rubber
- Leather and Fabrics
- Paper Patterns
- Honeycomb Cardboard
- And a lot more...

Main Applications

- Die-Cutting of Digital and Offset Prints
- Packaging prototypes and sample making
- Photo Albums
- Street and Business Signage
- Offset Varnishing Plates and Blankets
- Architectural and plastic models
- Reflective films / Stickers and Decals / Vinyl
- Motorbike Decals
- Membrane keyboards
- Patterns for Shoes and Fashion Industry
- And many more...



Invicta

is equipped with a vacuum table, divided into multiple zones to optimise the suction when media is smaller than the working area. Invicta comes in different sizes, all with high-res camera* for print cropmark detection software.

*Crop mark software and camera are optional



Invicta Series

SAVE SPACE WITH INVICTA 80

it is so compact that it fits into any workspace and adapts to most digital printing formats



Tools available

Invicta can be equipped with all tools compatible with the following tool holders:

- Multifunctional Tool Holder

- Versa-Tool Holder
- Fixed Tool Holder



MTH



VTH



FTH



QR code

PRECISION, EASE OF USE AND ENDLESS CREATIVE POSSIBILITIES



Invicta can be customized into different configurations depending on the tools chosen and can cut materials with thicknesses up to **5 mm (3/16")** with tangential cutting tool or up to **20 mm (3/4")** with oscillating knife. The Oscillating cutting knife will bring you to the next level. It will cut through many different materials from paper to rigid material or from fabric to leather.

Technical Data



Invicta Models	80	120	150
Cutting Size	610x810 mm (24x31")	1220x813 mm (48x32")	1524x1016 mm (40x60")
Width	1180 mm (46,4")	1780 mm (70")	2080 mm (82")
Depth	1394 mm (54,8")	1394 mm (54,8")	1594 mm (62,3")
Height	1100 mm (43,3")	1100 mm (43,3")	1100 mm (43,3")
Weight	140 kg (308 lbs)	290 kg (640 lbs)	320 Kg (683 lbs)
Max Cutting Speed	500 mm (20") / Sec		
Acceleration	0,5 m/s - (19,7")/s ²		
Power Requirements	Single Phase - 100/240V 50/60Hz 10°		
Power	1.7 KVA		
Air requirements	6 BAR (3,5 CFM) 8 BAR (5,3 CFM) with oscillating tool		
File Format	SVG, .PLT, .DXF, .CF2, .HPGL, .XML, .PDF		
Tool Change	Manual		
Tools Available	90°, 45°, 40°, Embossing, Creasing, Drawing tool, Oscillating tool and Kiss cut tool		
Tools Holder	1 + 1F		
Connectivity	USB 2.0/Bluetooth		
Buffer	External PC		
Media Hold System	Vacuum bed and Pneumatic Clamping System		
Fixed Tool	Pen (Optional)		
Cutting Capacity	0.1 > 5 mm (0.20") with Tangential cutting tool 0.1 < 20 mm (0.79") with Oscillating tool		
Repeatability	≤0.1 mm		
Supported OS	Windows 7, 10, 11		
CropMarks Rec.	Camera + Software (Optional)		

FEATURES

- **Single-head** system capable of a tool changeover in less than **10 seconds** without any mechanical adjustment.
- Invicta may be equipped with Opticrop Software for crop marks detection and print distortion adjustment.
- High versatility at an affordable price.

OPTIMA SERIES 80/160/250

DUAL-HEAD DIE-CUTTING MACHINE

Optima series is suitable for **almost every applications** in the offset/digital printing, display/packaging and apparel/leather markets.

It is the ideal solution for **short and medium runs** of die cutting, prototyping, honeycomb furniture creation, textile/cardboard pattern cutting and much more.

Thanks to its heavy-duty structure, its high-quality components and its versatility in processing different materials and thicknesses, Optima is considered one of the most demanded products by Valiani customers.

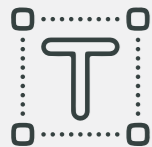
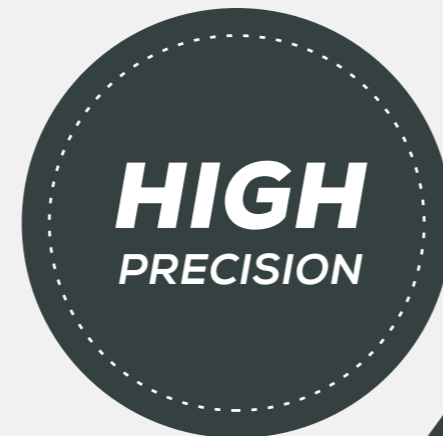

SIZES MATTER

Optima Series is available in multiple bed sizes.



TWO MODULAR TOOL HOLDERS

The possibility to easily swap one tool with another one enables the user to create the perfect configuration for various cutting requirements.



YOUR BEST INVESTMENT

1. High-quality and cutting precision for many materials
2. Perfect price-quality ratio
3. Low-cost maintenance



For more information scan the QR code or visit our website at www.valiani.com

Main Applications

- Contour cut of Digital and Offset Prints
- Box and Packaging Production
- POP/POS Displays
- Street and Business Signage
- Offset Varnishing Plates
- Architectural Models
- Motorbike decals
- Cardboard Honeycomb Furniture
- Patterns for Shoes and Fashion Industry
- Photo Albums
- And many more...

Materials

- Folding Carton and Corrugated Cardboard
- Vinyl / Plastic / Adhesive sheets
- Diamond Grade / Reflective sheets
- PVC and Foam Board
- Coating and Rubber Blankets
- Leather and Fabrics
- And a lot more...

Optima 80 | 160 | 250

Optima Series comes as standard with pneumatic fold-away clamps and vacuum table.



Optima Series

Tools available

Optima can be equipped with all tools compatible with the following tool holders:

• Multifunctional Tool Holder

• Versa-Tool Holder
• Fixed Tool Holder



MTH



FTH



VTH



FEATURES

- Equipped with two independent Tool Holders systems that allow multiple tool combination.
- Combines vacuum-assisted table and pneumatic fold-away clamping system.
- Incomparable working flexibility over a wide range of materials.
- Unparalleled cutting accuracy also on intricate designs.
- Customizable into various configurations depending on the tools chosen equippable with a software for crop mark detection and additionally with an optional packaging software.
- Available in 3 different bed sizes and one XL bed size.

Technical Data



Optima Models	80	160	250
Cutting Size	1230x820 mm (48.5x32")	1230x1630 mm (48.5x64")	1230x2500 mm (48.5x96")
Width	1830 mm/72"	1830 mm/72"	1830 mm/72"
Depth	1430 mm/56"	2230 mm/88"	3010 mm/118.5"
Height	1200 mm/47"	1200 mm/47"	1200 mm/47"
Weight	440 kg (970 lbs)	490 kg (1,080 lbs)	600 kg (1,322 lbs)
Max Cutting Speed	600 mm (24") / sec		
Acceleration	1 m/s ² - (39.4")/s ²		
Power Requirements	Single phase 208/220/230 V 50/60Hz 8.2A	Single phase 208/220/230 V 50/60Hz 8.2A	Single phase 208/220/230 V 50/60Hz 15.8A
Power	1.7 KVA	1.7 KVA	2.8 KVA
Air requirements	6 BAR/90 PSI (3,5 CFM) 8 BAR/115 PSI (5,3 CFM) with Oscillating tool		
Formato File	SVG, .PLT, .DXF, .CF2, .HPGL, .XML, .PDF		
Tool Change	Manual		
Tools Available	90°, 45°, 40°, Embossing, Creasing, Drawing, Oscillating tool and Kiss cut tool		
Tools Holder	2 + 1F		
Connectivity	Ethernet (USB 2.0*)		
Data Buffer	External PC		
Media Hold System	Vacuum bed and Pneumatic Clamping System		
Fixed Tool	Pen (Optional)		
Cutting Capacity	0.1 > 5 mm (0.20") with Tangential Blade 0.1 < 20 mm (0.79") with Oscillating Blade		
Repeatability	≤0.1 mm		
Supported OS	Windows 7, 10, 11		
CropMarks Rec.	Camera + Software (Optional)		

ONLY WITH US

5
YEAR*

WARRANTY

We are the only ones to offer these conditions!

Get peace of mind with a 5-year Valiani Limited Manufacturers' Warranty

* Ask your local dealer for warranty details.

OPTIMA XL 300



Main Applications

- Contour cut of Digital and Offset Prints
- Box and Packaging Production
- POP/POS Displays
- Street and Business Signage
- Offset Varnishing Plates / Rubber Blankets
- Architectural Models
- Motorbike decals
- Cardboard Honeycomb Furniture
- And many more...

EXTRA LARGE BED SIZE

Optima XL series combines the greatest features of Optima series with the opportunities of a **large format** machine, thus giving rise to a product designed to increase production capacity and perform multiple processes.

The large cutting surface in combination with the vacuum table guarantees a perfect media holding on a wide range of materials.

Thought to cut extra-large materials, it represents the ideal cutting machine both for those who need a **larger worktable** and looking for **productivity and guaranteed performance**.

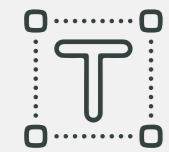

FROM SMALL TO LARGE

Optima and Optima XL Series are available in **four different cutting sizes**, covering from small to large cutting needs and offering the best price-quality ratio.

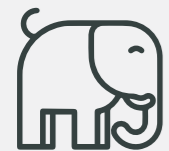

SUPERIOR MANUFACTURING, QUALITY AND RELIABILITY

All Valiani machines are designed and developed with the aim to make them **last forever**. Repeatability and reliability are two factors that summarize the concept of quality asseverated in Valiani.



MULTIPLE CROP MARKS DETECTION

Like in every Valiani Machinery, it is always possible to detect printing crop marks both for single sheet and for **multiple sheets**.

When the design is printed on smaller format, the system reads crop marks for each copy and accordingly performs a contour cut. Reverse side processing is another great feature when cutting and creasing delicate materials.

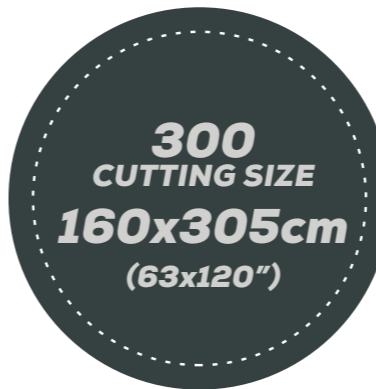

Technical Data

Optima XL Models	300
Cutting Size	1600x3050 mm (63x120")
Width	2200 mm / 86,6"
Depth	3640 mm / 143,3"
Height	1200 mm / 47"
Weight	690 kg / 1522 lbs
Power Requirements	3 - Phase - 230V 60Hz 20A 3 - Phase - 400V 50Hz 12A
Power	4.5 KVA
**For the other specs see page 25	

Tools available

Optima XL can be equipped with all tools compatible with the following tool holders:

- Multifunctional Tool Holder

- Versa-Tool Holder
- Fixed Tool Holder



MTH



FTH



VTH



INTEGRA SERIES 160/250/200/300

MILLING, CUTTING AND CREASING IN ONE SINGLE SOLUTION

Integra is a cutting system designed to process materials of **greater consistency** typical of the world of sign and packaging industry. Configurable with a **1 kW router** and a wide range of cutting tools, Integra guarantees high versatility and quality standards in managing the processing of the most common rigid supports used in the graphics industry. **Milling, engraving, cutting and creasing** in a precise way is now possible with Valiani Integra, a qualitatively impeccable Italian product that is characterized by its robust shape, high precision and reliability.



ROUTING TOOL

The 1 kW router to be mounted on the machine, can handle the processing of the most common rigid supports used in the graphic and sign industry including rigid PVC, acrylic, aluminum composite panels, forex and plexiglass up to 13 mm (0,5") thick. The router cutter reaches a maximum of 8 mm in diameter.



ONE DEVICE, PLENTY OF OPPORTUNITIES

Integra is the answer to cut, kiss-cut, creasing and routing demand as it is able to guarantee an optimal throughput without resorting to a cutting die. The machine is equipped with a high-resolution camera that, in combination with a software (optional), automatically detects the position of the registration marks for quick and precise contour cuts. The optimal fixing of the material is ensured by a vacuum table divided into multiple zones, other than the support of a foldaway clamping system.



MORE AUTOMATION FOR GREATER PRODUCTIVITY AND HIGHER SPEED

Integra's flatbed system makes use of a considerable degree of automation, with automatic adjustment of the cutting depth and full motorization of the two cutting heads. Integra turns out to be fast in processing materials with quick tool setup in relation to the height of the panel to be processed.



For more information scan the QR code or visit our website at www.valiani.com

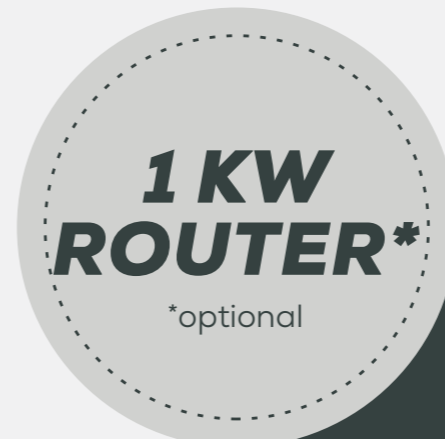

Main Applications

- Business and lettering Signage
- Custom Engraving Plates
- Gadgets
- Displays for Points of Sale and Purchase (POP/POS)
- Advertising Banners
- Die-Cutting of Digital and Offset Prints
- Packaging
- And many more...

Materials

- Plexiglass / Acrylic
- Dibond / Aluminum composite
- Plastic Materials
- Foamboard
- Medium-density fibreboard
- Folding and corrugated cardboard
- And a lot more...

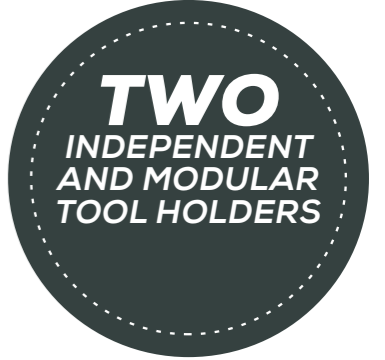

Automatic Tool Height Sensor

Fixed on the machine table, it makes it possible to automatically determine the tool height.

Integra Series



PRECISION, EASE OF USE AND ENDLESS CREATIVE POSSIBILITIES

Integra can be equipped with a 1 kW router to mill more rigid substrates like aluminum composites, forex, plexiglass up to 13 mm (0,5") thick.



Tools available

Integra can be equipped with all tools compatible with the following tool holders:

• Multifunctional Tool Holder

• Versa-Tool Holder
• Fixed Tool Holder



MTH



FTH



VTH



Technical Data

Integra Models	160	250	200	300
Cutting Size	1230x1630 mm (48,5x64")	1230x2500 mm (48,5x98,5")	1600x2050 mm (63x81")	1600x3050 mm (63x120")
Width	1830 mm/72"	1830 mm/72"	2200 mm/86"	2200 mm/86"
Depth	2230 mm/89"	3010 mm/119,5"	2730 mm/107"	3640 mm/143"
Height	1200 mm/47"	1200 mm/47"	1200 mm/47"	1200 mm/47"
Weight	540 kg/1190 lbs	590 kg/1300 lbs	650 kg/1433 lbs	690 kg/1521 lbs
Max Cutting Speed	1080 mm (42.5")/ sec			
Acceleration	2.5 m/s ² (98.4"/s ²)			
Power Requirements*	3 - Phase 400 V 50/60 Hz 17A	3 - Phase 400 V 50/60 Hz 23A	3 - Phase 400 V 50/60 Hz 23A	3 - Phase 400 V 50/60 Hz 23A
Power	6,5 KVA	9 KVA	9 KVA	9 KVA
Air pressure Requirements	6 BAR/90 PSI (3.5 CFM) 8 BAR/115 PSI (5.3 CFM) With Oscillating Tool			
File Format	SVG, .PLT, .DXF, .CF2, .HPGL, .XML, .PDF			
Tool Change	Manual			
Tools Available	90°, 45°, 40°, Embossing, Creasing, Drawing, Oscillating tool, Routing Tool 1 KW and Kiss cut tool			
Tools Holder	2 + 1F			
Connectivity	Ethernet + USB			
Data Buffer	External PC			
Media Hold System	Vacuum bed and Pneumatic Clamping System			
Fixed Tool	Pen (Optional)			
Cutting Capacity	0.1 > 5 mm (0,19") with Tangential Cutting head 0.1 > 20 mm (0,78") with Oscillating Tool head 0.1 > 13 mm (0,51") with Routing Tool			
Repeatability	≤0.1 mm			
Supported OS	Windows 7, 10, 11			
CropMarks Rec.	Camera + Software (Optional)			



VACUUM EXTRACTOR* FOR RESIDUES

An optional powerful aspirator is highly recommended to remove the residues left by the router and to give shape to a precise product on all sides.

*optional



Vacuum Extractor Technical Data

Integra Models	160	250	200	300
Power Requirements	EU 220-240V 50/60 Hz / US 110-120V 60Hz			
Power	KVA 3.6			

ONLY WITH US

5 YEAR*

WARRANTY

We are the only ones to offer these conditions!

Get peace of mind with a 5-year Valiani Limited Manufacturers' Warranty

* Ask your local dealer for warranty details.

* For electrical voltage different from the standard ones, it is necessary to use a power converter (that we can provide if any) to bring tension to 400V.

OMNIA SERIES 80/100

AUTO FEED DIE CUTTING MACHINE

Omnia has been designed to **automatically feed** and contour cut media to create exclusive packaging and unique labels. The operator can load different kinds of materials, with different sizes up to **75x80 cm / 29.5x31.5"** (Omnia 80) and up to **75x105 cm / 29.5x41.3"** (Omnia 100). Omnia will feed media to the cutting table using a suction system that lifts media from the feeder and drags it onto the conveyor. The feeder holds up to **600 sheets**, depending on thickness. Once in position, the camera will detect crop mark and execute the cut of the uploaded file. The processed sheets drop into the catch tray. The software can control multiple workflow options including cut files from various graphic design software, **QR Code mode**, and non-printed material. Omnia is perfect for die cutting cardstock projects including packaging, folders, business card and kiss-cut. With its robust design, it can also process heavy material such as corrugated cardboard, chip board, plastic sheets, forex and honeycomb board.

FEEDER CAN
STACK UP TO
600
SHEETS
OF 300 GSM
CARDSTOCK



INCREASE PRODUCTION CAPACITY

The oversized feeder and the withdrawal system automatically pick up and load the materials into the cutting machine. The automatic crop mark detection allows a hands-free cutting process and a **signal tower light** will notify the operator that the feeder has dropped to the minimum quantity so it can be reloaded.



REAL INDEPENDENT WORKFLOW

Omnia Series is designed with the aim to make it work **automatically all day long without the presence of an operator**. Repeatability and reliability are two factors that summarize the concept of quality asseverated in Valiani Omnia.

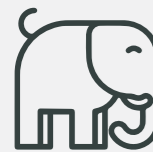

SUPERIOR MANUFACTURING, QUALITY AND RELIABILITY

All Valiani machines are designed and developed with the aim to make them **last forever**.



For more information scan the QR code or visit our website at www.valiani.com

FOR ANY
DIGITAL AND
OFFSET
PRINTING
HOUSES



Main Applications

- Packaging
 - Stickers and Labels
 - Business cards
 - Greeting cards and folders
 - Leaflets
 - Small POS Displays
 - Post press digital and offset finishing
- And many more...

Materials

- Folding carton and corrugated cardboard
 - Cardstock
 - Coated paper
 - Adhesives/Stickers/Vinyl
 - PVC/FOREX and Foam
- And a lot more...

OMNIA 80
MEDIA SIZE UP TO
75x80cm
(29.5x31.5")



MAXIMUM CUTTING HEIGHT
12.7 mm (1/2")
OSCILLATING TOOL*
*OPTIONAL

OMNIA 100
MEDIA SIZE UP TO
75x105cm
(29.5x41.3")



SAVE MONEY AND TIME
CHANGE CONVEYOR BELT BY YOURSELF

Distinguishing features for every Omnia model

- Signal tower light
- **Parallel** sheet feeding
- Conveyor with guide to prevent media from deviating from path
- Support for laptop
- Oversized catch tray
- Oversized feeder (20 cm - 7.87" capacity)
- Nonstop sheet media loading
- Safety mats



For more information scan the QR code or visit our website at www.valiani.com



10 Reasons Why

1. Continuous sheet media loading and processing
2. High-capacity Feeder 200mm
3. Perfect cutting and creasing on most materials
4. No operator needed / Unstoppable workflow
5. Cutting up to 12.7 mm - 1/2"
6. Kiss Cut Tool available
7. Processing rigid media too
8. Camera and software to ensure precise graphics alignment
9. Dual sheet feeding
10. 100% made in Italy



**SUPERIOR
MANUFACTURING,
QUALITY AND
RELIABILITY**

**AVG SPEED
PER SHEET**
is calculated between
35-45 seconds
when cutting a box
or a folder of medium
complexity

Omnia Series



Tools available

Omnia can be equipped with all tools compatible with the following tool holders:

• Multifunctional Tool Holder

• Versa-Tool Holder
• Fixed Tool Holder



MTH



FTH



VTH



Technical Data

Omnia Models	80	100
Cutting Size	750x800 mm (29.5x31.5")	750x1050 mm (29.5x41.3")
Width with PC	2190 mm (86.2")	2190 mm (86.2")
Depth	4085 mm (160.8")	4370 mm (172")
Height	1320 mm (52")	1320 mm (52")
Weight	890 Kg (1962 lbs)	950 Kg (2094 lbs)
Minimum Media Size	297x210 mm (A4) (11.6x8.2")	297x210 mm (A4) (11.6x8.2")
Maximum die-cutting size	740x790 mm (29.1x31.1")	740x1040 mm (29x41")
Width with safety mat	3280 mm (129.2")	
Max Cutting Speed	1350 mm (53.15") / sec	
Acceleration	4 m/sec - (157")/sec	
Power Requirements*	3-Phase - 400 V - 50/60 Hz 13A	
Power	5,5 KVA	
Air requirements	6 BAR/90 PSI (3.5 CFM) 8 BAR/115 PSI (5.3 CFM) with Oscillating tool	
File Format	SVG, .PLT, .DXF, .CF2, .HPGL, .XML, .PDF	
Tool Change	Manual	
Tools Available	90°, 45°, 40°, Embossing, Creasing, Oscillating tool and Kiss cut tool	
Tools Holder	2 + (1F)	
Connectivity	Ethernet + USB	
Data Buffer	External PC	
Media Hold System	Vacuum	
Fixed Tool	Multipurpose Drawing Tool	
Feeder Capacity	600 Sheets (300 gsm) - H. 200 mm (7,8")	
Cutting Capacity	0.1 > 5 mm (0,19") with Tangential Blade 0.1 > 12,7 mm (0,5") with Oscillating Blade	
Repeatability	≤0.1 mm	
Supported OS	Windows 7, 10, 11	
CropMarks Rec.	Camera + Software (Included)	



* For electrical voltage different from the standard ones, it is necessary to use a power converter (that we can provide if any) to bring tension to 400V.

TOOLS AND HOLDERS

The combinations between Tools and Holders make Valiani flatbed cutting machines the ideal solution for many applications and materials.



HOLDERS

All Valiani cutting machines are based on a modular tooling system that enables to assemble different tools from a set of common building blocks. Thanks to this system, users can quickly assemble tools for different finishing process. This reduces the time of tool changeover and boosts productivity.



TOOLS

Valiani has an array of tools that fit onto a multifunctional tool holder to enlarge the range of cutting process available on some models such as Oscillating knife, V-Cutting, Kiss cutting and many others. Valiani Tools grant the users both **Modularity** and **Quick-Change** capability. This versatility represents a gain in the machining capacity, improving the return on the users capital invested in the machine.



INTERCHANGEABLE HEADS (TO BE COMBINED WITH VERSATOOL)







Valiani has also an array of interchangeable heads for their entire line of flatbed cutters. These heads are retained and positioned on the cutting head assembly by means of several small, yet powerful magnets, which make locking faster and hardware unnecessary. A dedicated wedge-fork is supplied with the heads which makes easy, safe and fast the head change. Each tool head is color-coded and numbered to help simplify recognition at a glance.



For more information scan the QR code or visit our website at www.valiani.com



LEGEND

Tool Holders		
		
MTH Multifunctional Tool Holder	VTH Versa-Tool Tool Holder	FTH Fixed Tool Holder
Machines		
		
IN Invicta	OP Optima	IG Integra
		
OM Omnia		



Holders

Multifunctional Tool Holder - (MTH) **IN** **OP** **IG** **OM**



The Multifunctional Tool Holder is designed to fit many different tools. The simplicity of this tool holder makes it very easy to change from one tool to another. A simple locking system allows the operator to change tools anytime the cutting process requires, in less than 10 seconds. This feature translates into the possibility of having countless tools on the machine regardless of the number of the tool holder modules. The Multifunctional Tool Holder comes as standard with a manual adjustment to set blade depth or creasing pressure. Holder can be operated in pressure or position mode.

- **Quick Tool Change and No calibration needed**
- **High Precision Adjustment Setup**
- **Long Life and Heavy-Duty Equipment**

VersaTool Holder - (VTH) **IN** **OP** **IG** **OM**



The VersaTool is the essence of the **All-in-One tool**, it is designed to fit all the interchangeable cutting heads. The VersaTool, in combination with the right cutting heads, is ideal for half cut and straight cut on varnishing plates / rubber blankets, on any type of cardboard and v-cut on chip grey boards. Thanks to the **patented magnets system**, tool change timing is drastically reduced, safeguarding cutting precision and increasing machine's productivity. **VersaTool Holder** can be equipped with 40°/45° beveled cutting heads, embossing/debossing, creasing, and 90° cutting head.

- **Quick Tool Change and No calibration needed**
- **Versatility and reliability**
- **Limitless expandability / No Obsolescence**

Fixed Tool Holder - (FTH) **IN** **OP** **IG** **OM**



On Valiani machines it is possible to mount fixed pen tool holders in addition to the ones provided by default. This tool holder supports every type of pen, pencil and felt-tip pen, thought to draw and write on many materials including cardboard and paper patterns for apparel market.



Powerful Pneumatic Oscillating knife (PPO)



For thick honeycomb cardboard, composite foam, coroplast, forex and a lot of many more materials. The oscillating cutting tool is a pneumatically powered tool, ideal for cutting heavy strength materials up to 20 mm (3/4")* but it can also handle thinner and softer ones. The combination of the air pressure strength and the 8 mm stroke make it suitable for a wide range of applications.

- **Powerful and low-maintenance pneumatic tool**
- **8 mm stroke/ 9.000 Bpm**
- **20 mm (3/4") cutting capacity***
- **Compatible with MTH**

Blade type:
oscillating
round shank
blades

*Depending on material rigidity

MATERIALS



Honeycomb board



Pvc/Forex

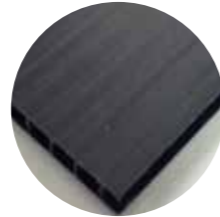

Coroplast



Rubber Gaskets

Multipurpose Tangential Drag knife - (MTD)



For folding and corrugated cardboard, vinyl, thin plastics and a lot more materials. The tangential cutting tool is a precise multi depth tool, capable to handle material up to 5 mm (3/16") thick. The tangential knife allows to cut at full speed releasing very high-quality finishes. The tool is always **included** on all machines except Invicta.

- **High-quality finishing**
- **Versatile, handles most thin materials**
- **5 mm (3/16") cutting capacity**
- **Compatible with MTH**

Blade type:
Pulling flat
blades

MATERIALS



Folding Cardbord



Single Corrugated board

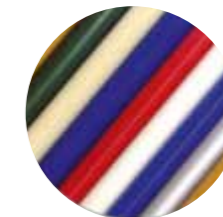

Vinyl



Grey-board

High-speed Pneumatic Oscillating knife (HPO)



Ideal on textile, foam, polyethylene and corrugated materials. The High-speed Oscillating cutting tool is a pneumatically powered tool that combines performance with extreme precision. The 8 mm stroke and the high oscillating frequency make it capable to process softer and thinner materials at **higher speed**, reaching excellent quality level.

- **High performance**
- **8 mm stroke/14.000 Bpm**
- **20 mm (3/16") cutting capacity on softer materials**
- **Compatible with MTH**

Blade type:
oscillating
flat blades

MATERIALS



Multi-flute Corrugated board



Textile and Leather



Foam-board



Micro Corrugated Sheet

Kiss-cut Tangential knife - (KCT)



The Kiss Cutting Tool is a tool designed to peel the top-layer of materials up to 1.2 mm thick. Thanks to its mechanically controlled blade, it can perform cuts with extreme accuracy. Equipped with a blade guide, the tool provides consistent and precise control over the cutting depth for various applications, from vinyl stickers to labels and decals.

- **Type: Spring-controlled pressure**
- **Control: Manual, rotating disc on tool holder**
- **Pressure: Springs up to 120g, 650g e 1800g**
- **Blades: Tangential**

MATERIALS



Paper <200gr

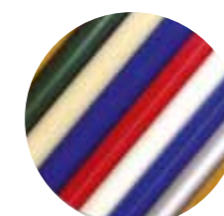

Adhesive vinyl / Sandblast

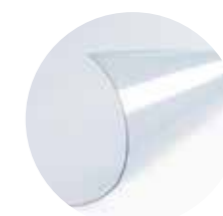

Adhesive PVC Banner



Protective film



⚙️ Universal Creasing Tool – (UCT)



The Universal creasing tool is a multi-use tool that comes as standard with 9 wheels with creasing and perforating functions. The tool is able to crease a wide variety of folding cardboard, polypropylene, single flute sheets, etc. Wheels can be easily changed thanks to the magnetic holding system.

- **Adjustable creasing pressure**
- **Clean and precise creases**
- **Wheels easy mount**
- **Compatible with MTH**

WHEELS AVAILABLE

- *Set of creasers for Folding Cardboard (3 pcs)*
- *Set of creasers for Corrugated Cardboard (3 pcs)*
- *Set of perforating wheels (3 pcs)*

Ø16 - Ø32

MATERIALS



Folding cardboard



Micro Corrugated Sheet

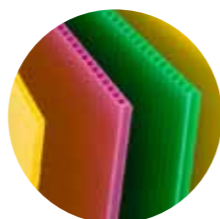

Polypropylene Honeycomb



Archival Corrugated Board



⚙️ Multi-Wall Creasing Tool – (MCW)



The 4 Multi-Flute(s) creasing wheels have been designed to handle double and triple flute corrugated board. They work in combination with a special creasing tool to be bought separately.*

The larger diameter of the creasers allows to produce fine creases both with and against the corrugation, Multi-Wall Creasing Wheels can be easily changed thanks to the magnetic holding system.

- **Wheel easy mount**
- **Clean creases on double as well as triple walls**
- **Adjustable creasing pressure**
- **Compatible with UCT**

*Multi-wall creasing tool and wheels are optional upon request, not included within the above Universal Creasing Tool.

Ø60

MATERIALS



Single-Wall Corrugated Cardboard

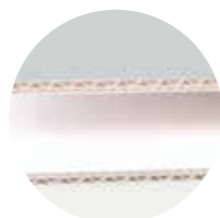

Double-Wall Archival Cardboard



Triple-Wall Corrugated Cardboard

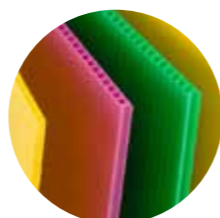

Polypropylene Honeycomb



⚙️ Plot Drawing Tool – (PDT)



For those needing to write part numbers or job names on items prior to cutting. The Plot Drawing Tool is available for the tool holder body and it takes standard pen cartridge ball point.

This tool is also ideal to label materials such as cardstock with text, marks or symbols.

- **High speed**
- **Quick pen change**
- **Ideal for text or marks on cardstock**
- **Compatible with MTH**

MATERIALS

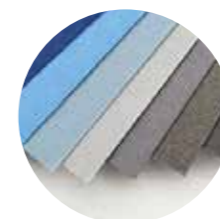

Folding Cardstock



Heavy cardstock for apparel patterns

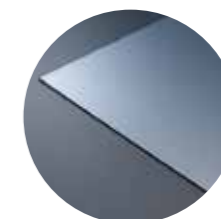

Polycarbonate

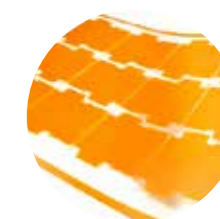

Varnishing Plates



⚙️ V-Cut and Bevel Tool – (VBT)



The V-Cutting tool is a specific tool for creating beveled edges and folding thicker materials. The Tool is the ideal for producing three-dimensional structural designs made of honeycomb cardboard, foam-core materials or light coroplast display board. The tool has multiple blade holders* to produce bevel cuts at 15°, 22.5°, 30° (optional) and 45° (included). Thickness capacity ranges between **6 mm (0,23")** and **16 mm (0,62")**.

- **Heavy-duty**
- **For display racks and large-sized cardboard structures**
- **Variable angle***
- **Compatible with MTH**

*15°, 22.5°, 30° blades are optional upon request, not included within V-Cut Tool.

*Available on Optima and Integra only

MATERIALS



Honeycomb board

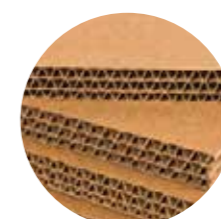

Triple-Wall Corrugated



Cardboard Composite Foam

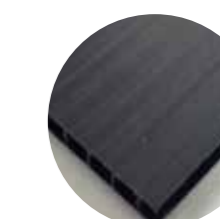

Coroplast

Routing Tool (RT)



The 1 kW router, to be mounted on **Integra**, can handle the processing of the most common rigid supports used in the graphic and sign industry, including rigid PVC, acrylic and aluminum/dibond composite panels and plexiglass up to 13 mm thick; allowing to produce a perfect finishing of printed materials and much more. Max recommended milling bit diameter of 8 mm.

- **Speed range 5.000 - 60.000 rpm**
- **Tool change: manual wrench**
- **Max diameter routing shank 8 mm**

MATERIALS



Aluminum composite



Medium-density Fiberboard

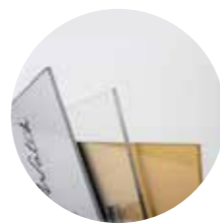

Plexiglass/Acrylic



Pvc/Forex

Interchangeable Heads

To be combined with VersaTool

White 90° - Straight Cut and Half-Cut (IHW)



The 90° White head has been developed to cut a wide range of materials up to a thickness of 6,3 mm (1/4"), as well as to perform half cut. It comes as standard with one pressure roller and a teflon foot. It's ideal for grey cardboard in combination with 45° blue head to create Luxury Packaging and extremely effective on rubber and varnish blankets.

- **Multi-purpose cutting head**
- **Half-cut tool**
- **Clean & precise cutting of varnish and rubber blankets**
- **Compatible with VersaTool Holder**

MATERIALS



Grey board



Luxury packaging board

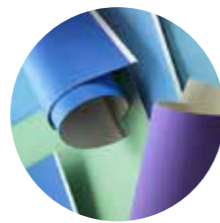

Varnishing plates and rubber blankets

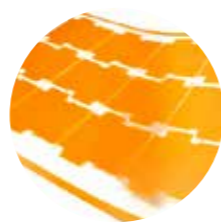

Polyester-based Varnishing Plates

Green 40° - Bevel Cut - (IHG)



The 40° - Green head produces a bevel cut at 40° angle, ideal for both cutting small shapes and traditional bevel cutting. It cuts up to 2.3 mm (0,09"). Recommended for mat-board and polyester-based varnishing plates.

- **Ideal bevel cutting tool for matboards**
- **Intricated design cut on polyester based varnish plates**
- **Compatible with VersaTool Holder**

MATERIALS



Standard mat-board up to 2.3 mm (6ply)

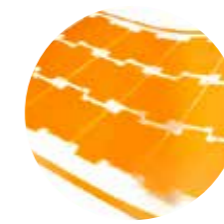

Polyester-based Varnishing Plates



Suede Mat-board



Thin museum archival board

Blue 45° - Bevel Cut - (IHB)



The 45° - Blue head produces a bevel cut at 45° angle. This head can cut up to **5 mm (3/16")** and performs V-Cutting as well. This application is highly demanded in the field of luxury packaging and more precisely to create rigid boxes. Excellent results are also obtained while cutting grey board and foamboard.

- **More pronounced bevel cut on matboards**
- **Ideal for high-end luxury boxes**
- **Fine edges on V-cuts**
- **Compatible with VersaTool Holder**

MATERIALS

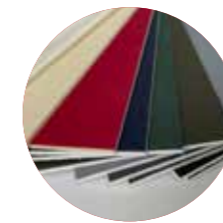

Standard mat-board up to 5 mm (3/16")



Foamboard up to 5 mm (3/16")

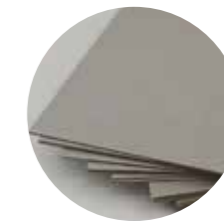

Grey Board up to 5 mm (3/16")



Luxury packaging board



Purple - Embossing / Debossing - (IHP)



The Embossing/Debossing Head – Purple head includes 4 different tip types and it is used to create decorations by applying pressure on different materials. Any shape or design can be elegantly embossed/debossed on the surface of the material depending on its rigidity and consistency.

- Give your design another dimension
- Raise the surface of your design
- Ideal for braille applications
- Compatible with VersaTool Holder

MATERIALS

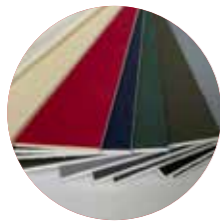

Standard mat-board up to 2.2 mm (6ply)



Coated and laminated paper

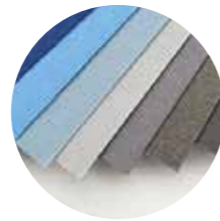

Folding Cardstock



Braille



Grey 90° - Straight Cut - (IEH)



The 90° - Grey head has been developed to perform a straight cut on a wide range of materials up to a thickness of 5 mm (3/16"). It releases a perfect finishing results on folding and corrugated cardboard, vinyl adhesives, thin plastics and more. It has the same function of the multipurpose tangential knife.

- Universal straight cutting tool
- It comes as standard with a metal and teflon foot
- Compatible with VersaTool Holder

MATERIALS



Grey-board



Multi-flute corrugated board



Paper Patterns



Cristal Adhesives



Brown - Creasing/Scoring (IHBr)



The Packaging - Brown Tools set consists of one head with 9 wheels of various geometry, which have been developed for the packaging market for those who need to crease cut cardstock, flute board, corrugated board and polypropylene. It has the same function of Universal Creasing Tool.

- Adjustable creasing pressure
- Clean and precise creases
- Wheels easy mount
- Compatible with VersaTool Holder

WHEELS AVAILABLE

- Set of creasers for Folding Cardboard (3 pcs)
- Set of creasers for Corrugated Cardboard (3 pcs)
- Set of perforating wheels (3pcs)

MATERIALS



Folding cardboard



Micro Corrugated Sheet

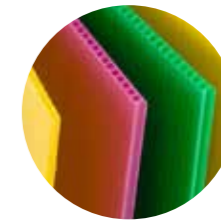

Polypropylene Honeycomb



Archival Corrugated Board

Brown - Creasing Wheels (Part of IHBr)

WHEELS



1

Perforating tool: Serrated cut wheel, Ø 32 mm, 2-1 mm step.



2

Blade tool: Metal wheel, Ø 32 mm diameter.



3

Perforating tool: Serrated cut wheel, Ø 32 mm, 3-1 mm step.



4

Scoring tool: 32 mm diameter, 2 mm round crest.



5

Scoring tool: 32 mm diameter, 1.5 mm round crest.



6

Scoring tool: 32 mm diameter, 1 mm round crest.



7 Scoring tool: 16 mm diameter, 0.7 mm round crest.

8 Scoring tool: 16 mm diameter, 1 mm round crest.

9 Scoring tool: 16 mm diameter, 1.5 mm round crest.

Fixed Tools



Multipurpose Drawing Tool (MDT)

On every machine it is possible to mount a fixed tool as a third or second optional tool depending on the machine model. The Multipurpose Drawing tool is very user-friendly since it takes standard drawing tools such as felt-tip pens and ballpoint pens.

- Available for Invicta, Optima, Integra and Omnia
- Precise on any type of writing or decoration
- Works with any type of pen
- Compatible with Fixed Tool Holder

MATERIALS



Mat-board



Cardstock



Paper Patterns

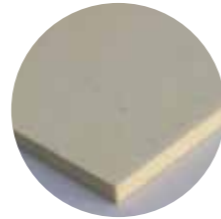

Woodboard



PEN CARTRIDGES (INCLUDED)



1 Bronze/Gold:
Upper and lower diameter 15-8.5 mm



2 Black/Red:
Upper and lower diameter 8.5-5.5 mm

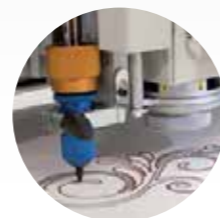

3 Orange/Blue:
Upper and lower diameter 11-5.8 mm

SOFTWARE AND PROGRAMS

What makes Valiani special is the ability to integrate innovative and extremely easy-to-use software solutions.

You can choose among different software and applications to make your Valiani perform at its best.



V-STUDIO

V-Studio is the Valiani desktop application software, developed to improve the man/machine experience. Thanks to an optimized design environment and equipped with innovative tools, users will be able to cut any .SVG, .PDF and .PLT, as well as .CFF2 and DXF.

This user-friendly software makes it easy producing customized packaging models* and perform contour cuts on pre-printed materials. With the intuitive user interface and powerful toolset, anyone can cut a job like a pro after a short training.

*Packaging models are within the M3 or M3 Art software.



OPTICROP

OptiCrop is the software that allows you to manage contour cut on pre-printed images and create endless application.

Used in conjunction with a high-resolution camera, it allows you to identify crop marks, realign graphics to match them and adjust the print skew.



M3 AND M3 ART

M3 and M3 Art software are the perfect way to start producing boxes and POP/POS Displays. Using their large parametric library, that includes models for folding carton, corrugated board, honeycomb board and rigid grey board, you have virtually endless possibilities.



For more information scan the QR code or visit our website at www.valiani.com

V-STUDIO

THE SIMPLEST WAY TO MAKE THE BEST FROM YOUR VALIANI



FULL CONTROL OVER YOUR VALIANI

You can set plotting process, tools, pressure and speed, overcut, multi-cut, blade offset, mirroring, cut selection only and many others.



SUPPORTING MOST COMMON GRAPHIC SOFTWARE

Works perfectly with Adobe Illustrator or Corel Draw through .SVG or .PDF file format, CAD software through .DXF file format and last but not least most of the Packaging CAD through .CFF2 file format. Other file formats for importation from graphics R.I.P available.

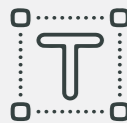

CONTOUR CUTTING

Adds crop marks over your print with a script for Adobe Illustrator and a Macro for CorelDraw, recognizes different plotting process through predefined color strokes and allows new pairing when needed, a colors swatch is also available for both graphic software.



DETECTING CROP MARKS

Reads crop mark of multiple sizes and shapes, including white marks on dark materials. Manages single sheet, multiple poses, or large print with multiple crop marks, as well as layers and groups to optimize cutting workflow.



PROTECTING YOUR BUSSINESS

Stores your machine configuration on our Cloud making easier a configuration restore and prevents from losing data.



REASSURING

Guarantees free updates* on V-Studio from Valiani website so that all users could always benefit of the latest features.



MANAGING MATERIALS DATABASE

Optimizes the software usage by storing all your materials details including their cutting parameters, relevant tools and blades, cutters or creasers.



UNIVERSAL COMPATIBILITY

If English is not your first language, V-Studio is available in 10 more languages which includes Italian, French, Spanish, Japanese, Chinese, Russian, Flemish, German and Korean.

*Latest software might not be compatible with oldest hardware, please contact customer support before proceeding.



For more information scan the QR code or visit our website at www.valiani.com



For more information scan the QR code or visit our website at www.valiani.com

- Fully compatible with Adobe Illustrator and Corel Draw.
- Cutting process through colors matching.
- QR/BarCode File Import.
- Integrated with most of Packaging CAD.
- Capable to handle most common vector file formats (.SVG, .PLT and .PDF).
- VXML file format compatibility for both Output and input.
- Available for Windows 11, 10, 8 and 7.
- Translated into 10 languages.
- Optimize cutting path to reduce working time.
- Option to cut only selected objects.
- Capable to import 2D project from most of CAD software through .DXF file format.



M3 AND M3 ART

EVERYTHING YOU NEED TO REALIZE PACKAGING AND POP / POS DISPLAYS

M3 and M3 Art software are the perfect way to start producing boxes and POP/POS Display. Using their large parametric library, that includes models for folding carton, corrugated board and rigid honeycomb board, you have virtually endless possibilities.

m3 is a complete library of parametric models and designs, specially designed for Valiani cutting machines. M3 is structured to give the possibility to modify, resize and cut boxes, displays and other 3D objects made with cardboard and many packaging materials.

m3 art is a combination of features that allows graphic designers the flexibility to work directly in Adobe Illustrator using file boxes or POP / POS displays and benefiting from their parameterization.

Native M3 files can be opened in Illustrator without conversion and can be processed within the same work environment. Focusing on the visual aspect of the design process, M3 Art offers intuitive 3D prototyping and realistic visualization of the different types of material, printing and finishing. This integration allows graphic and CAD software to complement each other by increasing productivity without requiring any effort.



For more information scan the QR code or visit our website at www.valiani.com

m3



M3 Library of Packaging Designs

The M3 Library of resizable packaging standards comes with approx. **600** parametric designs for folding carton, corrugated board, grey board and PVC. From Version 2023, M3 includes **50** templates for archival storage and conservation boxes.

- A parametric library available both in millimeters and inches.
- Integrated Index file with sections for different materials.
- Support of the ECMA and FEFCO standard designs.
- Resizing and automatic structural modification

by parameter editing.





m3 art

M3 Art Library of packaging design

The **M3 Art** Library of resizable packaging standards has accumulated around **2.300** parametric designs for folding carton, corrugated board, grey board or luxury boxes, rigid honeycomb board and PVC.

Together with the **200** patterns of displays, the user has over than **2500** available templates.

The full ECMA and FEFCO codes have been parametrized and included in the Library among many others.

A parametric Library available both in millimeters and inches.

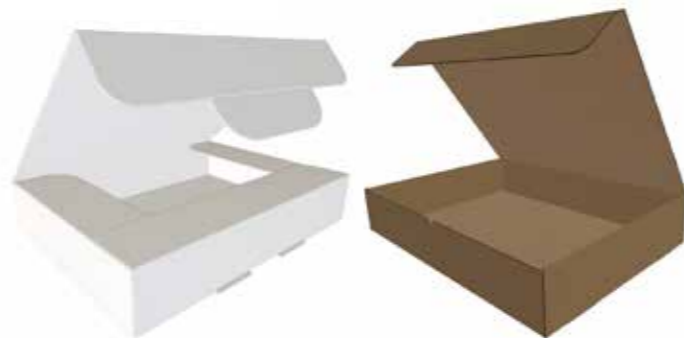

Archival Storage and Conservation Boxes

The **M3 and M3 Art** Library now also includes **50** templates for archival storage and conservation boxes.

- Clam-shell trays
- Storage boxes
- Envelopes
- Multi-Side wraps
- Slips cases

*Available for both, M3 and M3 Art.

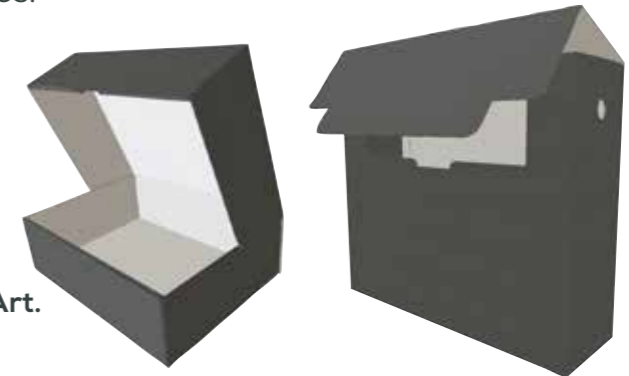

M3 Art Library of Displays

The **M3 Art** Library of displays and multipart structures includes around **200** resizable designs for corrugated board and rigid board materials. The 2D and 3D designs can be opened in the M3 ART CAD software or directly in Adobe Illustrator, where graphic designers can create the graphics and generate production files with high resolution images.

- POP/POS structures come as free-standing displays, counter displays, walls, stands, furniture.
- Design recalculation takes place automatically after material thickness is changed. This minimizes design time and eliminates repetition induced errors.
- Multiple-material structures are featured.
- 3D folding sequences are integrated into display library designs for complete presentations. They can also be used for assembly instructions.

*Only M3 Art.

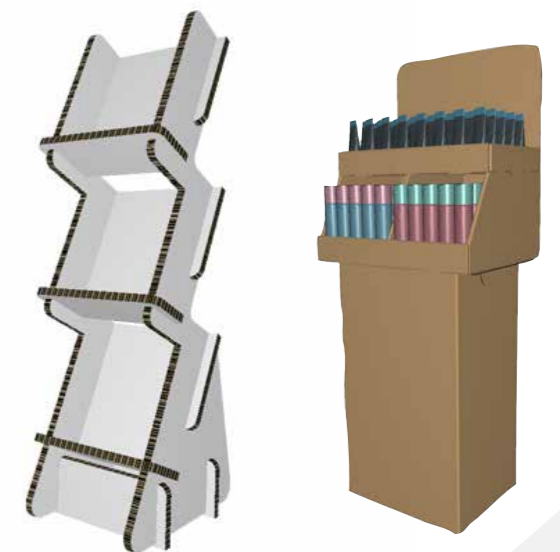

M3 ART Cardboard Furniture

M3 Art offers some unique templates for creating eco-friendly furniture, totally customizable in shape and finishes.



*Only M3 Art.

M3 ART Library of Luxury Boxes

M3 form version.9 supports grey board designs also known as **luxury boxes**. Luxury boxes consist of packaging materials that have been developed and tailored to give the goods a distinctive touch. These boxes are usually made with rigid material such as grey board and wrapped by a card of excellent finish to make them more appealing to customers, while still serving their purpose.

Some examples of:

- Body and Lid.
- Trays with Hinged Lid.
- Magnetic Closure boxes.
- Shoulder and Neck Boxes.
- Slipcase.

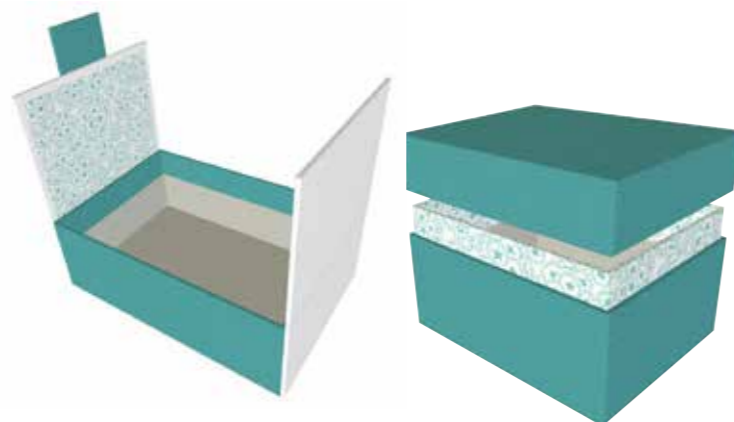

*Only M3 Art.

3D Presenter

The 3D module allows realistic visualization and proofing of the 2D structure of the artwork of packaging and **POP/POS displays**. At every step of the creation process, the designer can see the changes apply in 3D and share the prototype with colleagues and clients.

- Definition of the folding sequence, navigation and animation of the 3D model.
- Insertion of 3D parts for assembling multiple POP/POS displays and structures.
- 3D dimensioning.
- Realistic visualization of materials with their folded and cut edges.
- Generation of 3D animated PDF for easy sharing with customers.

*Only M3 Art.

Integration with Adobe Illustrator

M3 ART packaging software is integrated with Adobe Illustrator*. The **plug-in** lets graphic designers easily apply artwork onto structural drawings. Verifying the results in the 3D environment happens quickly and without efforts.

*Only M3 Art.

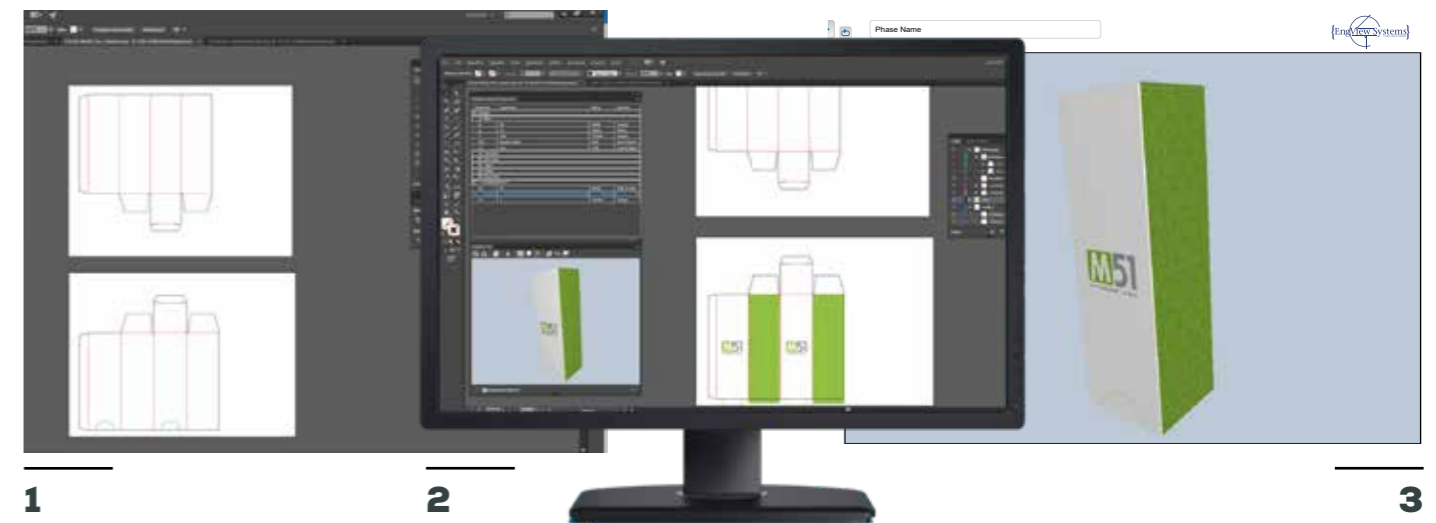

LEGEND

1. Template can be edited and resized directly in Adobe Illustrator.
2. Graphics can be applied directly on AI and visualize through the 3D presenter.
3. A 3D animated PDF can be generated to share the final project.

OPTICROP

GIVING SHAPE TO PRINTS

ADVANCED CROP MARK DETECTION SYSTEM

OptiCrop is the software that allows you to manage contour cut on pre-printed images and create endless application. Used in conjunction with a high-resolution camera, it allows you to identify crop marks, realign graphics to match them and adjust the print skew.



CROP MARK DETECTION

Once the camera is positioned on the first printing mark, OptiCrop automatically detects the 2nd, 3rd and 4th marks, redrawing the artwork according to its position on the cutting table. Retry mode is a time saving feature that allows the user to repeat the crop mark acquisition cycle should they not be found at the first attempt.



PRINT ALIGNMENT

Through the crop mark detection Opticrop is capable to straighten the cutting trace and compensate any print distortion. This operation can be performed on a single sheet or even on multiple sheets. Number of crop mark determines the precision of contour cutting. 4-crops ensure maximum precision for any kind of distortion, whereas 2 -3 crops can be faster but with limited compensation.



VECTOR FILE IMPORT

OptiCrop works with .SVG (Adobe Illustrator or Corel Draw), .VXML, and PDF files.

OptiCrop works with vector files, it is possible to set-up plotting process using different pen colors on your artwork. It is also possible to use group function and layers to optimize work flow. This feature also recognizes different colors and allows the user to set-up halftone colors.



For more information scan the QR code or visit our website at www.valiani.com



- Straightening cutting process available up to +/- 44°.
- QRcode import - QRcode can be used to identify the job and automatically load it. QR code can be acquired directly by the built-in camera.
- Barcode import - Barcode can be used to import file.
- Squared and rounded shape crop marks, whether black or even white on a dark background.
- Customizable registration crop mark sizes.
- Mirror Mode for Reverse side processing.
- Quick crop mark detection time.
- Print distortion compensation.

Customer Experience Center

"From Briefing to Experience: from this concept comes the idea of creating a place to support our customers and present our latest products and technologies but, above all, to truly connect customers with our organization.

We recognize that customers want more than to be talked to – they want an experience that feels both personal and authentic."

Nico Valiani



Live a fully personalized experience

Your time is valuable. This is why We work to provide any customer a unique and personalized experience, for which our team will work directly with you to identify the objectives of the meeting before the visit.



Interact with experts

Whether you want to have a deep discussion on a particular machine in the Valiani portfolio, or a deeper conversation about the available tools, the type of material the machine can cut or additional software, you'll be directed to the right products.



Discover industry trends

Industries are evolving every day and so are the need for improved technology. Our teams regularly conduct and review market research on each of the industries we serve, to provide you a deep understanding of the important trends that are likely to impact your business. Then we can discuss how you can best respond to them to capture and preserve your edge for the years to come.

Full range of products



Our Valiani Customer Experience Center features our most recent products and solutions.



**Visit our
Showroom**





DOWNLOAD OUR
CATALOGUE



Valiani srl
Via delle Regioni 305,
50052 Certaldo - Firenze - Italia
www.valiani.com - info@valiani.com

follow us



WATCH THE
COMPANY VIDEO